

# Tilt and Slider Replacement Window Installation Instructions



*Installer – Please leave this booklet for the homeowner after the install is completed.*

## ⚠ ⚠ CAUTION - IMPORTANT ⚠ ⚠

Lead-based paint may be present in older homes, and the removal of windows & doors may cause this paint to be disturbed. In order to minimize exposure to lead-based paint dust, please consult [www.epa.gov/lead](http://www.epa.gov/lead) for more information.

**IMPORTANT:** Please read completely before you begin.

## Tilt and Sliding Replacement Window

### Table of Contents and Tool/Material Requirements

	START PAGE
<b>Components; General</b>	iii
<b>Typical Wood Window Components</b>	iv
<b>Safety Alert Symbol; Synthetic Stucco</b>	v
<b>Sash Removal</b>	1
Pry Bar, Hammer, Utility Knife, Screwdriver, Stiff Bladed Putty Knife	
<b>Opening Preparation</b>	2
Hammer, Screwdriver, Pry Bar, Fiberglass Insulation, Putty Knife, Level, Tape Measure, Stiff Brush, Wood Chisel	
<b>Window Installation – Check Fit</b>	4
<b>Window Installation For Units Without Sill Angle Bracket</b>	5
Measuring Tape, Hammer, Electric Drill w/Screwdriver Bit, Pry Bar, Shims, Level, Silicone Sealant, Caulking Gun, Finish Nails, Nail Set, Inside Stops, Tilt & Slider – #8 x 2-1/2" Bugle Head Screws, Slider – #10 x 2-1/2" Truss Head Screws	
<b>Window Installation For Units Using The Sill Angle Bracket</b>	6
Measuring Tape, Hammer, Electric Drill w/Screwdriver Bit, Pry Bar, Shims, Level, Sill Angle Bracket, Silicone Sealant, Caulking Gun, Finish Nails, Nail Set, Inside Stops, Tilt & Slider – #8 x 1/2" TEK Screws, #8 x 2-1/2" Bugle Head Screws; Slider – #10 x 2-1/2" Truss Head Screws	
<b>Optional Exterior Trim Application</b>	12
<b>Tilt Window Lock and Unlock</b>	14
<b>Tilt Window Sash Removal</b>	15
<b>Tilt Window Sash Reinstall</b>	16
<b>Tilt Window Screen Removal and Reinstallation</b>	18
<b>Sliding Window Lock and Unlock</b>	19
<b>Sliding Window Sash Removal</b>	20
<b>Sliding Window Sash Reinstall</b>	21
<b>Sliding Window Screen Removal and Reinstallation</b>	23
<b>Recommended Finishing Instructions</b>	24

**Customer may need to supply replacements for the following:**

- Interior Casing Mouldings
- Inside Stop Mouldings
- Outside Stop Mouldings

**▲ IMPORTANT:** Thoroughly read and follow these instructions. Failure to install as recommended will void any warranty, expressed or implied. **Before installation, check building codes for the area in which the windows are being installed, to ensure proper compliance.** The installation instructions that follow are based on typical frame construction. Specific applications may differ. Weathershield Mfg., Inc. recommends that you consult a qualified installation professional. Weathershield Mfg., Inc. is not responsible for installation.

**These replacement windows must be installed from the interior.**

Weathershield Mfg., Inc. reserves the right, as necessary, to change product specifications, installation procedures, materials, prices and terms of purchase without notice.

## Tilt and Sliding Replacement Window

### Components

Each Replacement Unit ships with the following:

Qty.	Description
1	Window Unit Complete With Sash, Frame and Operating Hardware
32	Installation Shims
6	#8 x 2-1/2" Phillips Bugle Head Screws – <b>Tilt</b>
1 Pkg	18' of 1/2" Backer Rod
6	#10 x 2-1/2" Phillips Truss Head Type A , Tan Head, Screws (side jambs) – <b>Slider</b>
2	#8 x 2-1/2" Phillips Bugle Head Screw (head jamb) – <b>Slider</b>
1	Installation Instruction Booklet
Optional Contents	
1	Sill Angle Support Bracket (see below)
4	#8 x 1/2" Phillips Pan Head, TEK SS410, Full Thread Screws
1 Set	Pre-Cut, Color-Matched Aluminum Trim Extenders

The sill angle support bracket is provided with some units. It helps support the window and fills the gap between the unit's sill and the old window sill (**FIGURE 1**).

FIGURE 1

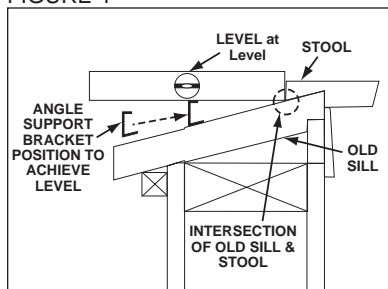

Other units may have sills sloped to fit your specific opening. Sloped sill units do not require the angle support bracket (**FIGURE 2**).

FIGURE 2

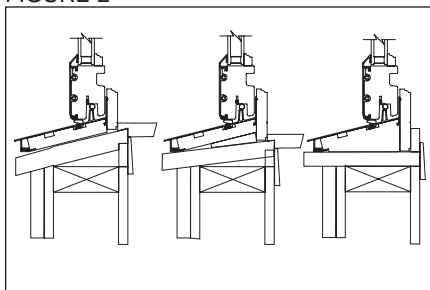

### General

Installing your new Replacement Window requires removing existing window parts, test fitting, and installing your new unit.

Typical wood window components are shown on the following page in (**FIGURE 1**). Refer to this diagram for terms used in these instructions.

Completely read the installation instructions before starting any procedure.

**▲ IMPORTANT: Wear full protective clothing including gloves and safety glasses.**

Optional factory-applied finishes should be handled with extra care to prevent damage.

## Tilt and Sliding Replacement Window

### Typical Wood Window Components

FIGURE 1

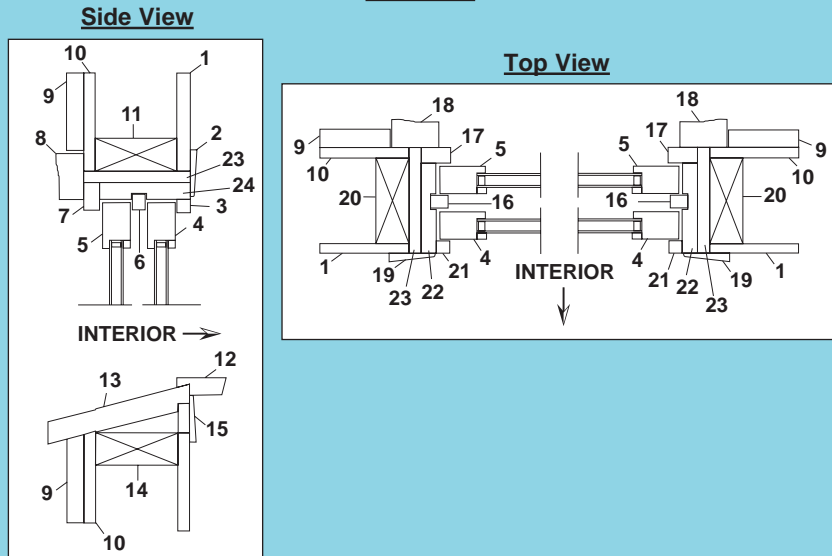

1. Drywall
2. Interior Top Casing
3. Head Inside Stop
4. Bottom Sash
5. Top Sash
6. Head Parting Stop
7. Head Outside Stop (Blind Stop)
8. Head Brick Mould
9. Exterior Siding
10. Sheathing
11. Header
12. Stool
13. Sill
14. Rough Sill
15. Interior Apron
16. Side Parting Stop
17. Side Outside Stop (Blind Stop)
18. Side Brickmould
19. Interior Side Casing
20. Trimmer Stud
21. Side Inside Stop
22. Side Jamb
23. Shim Space
24. Head Jamb

## Tilt and Sliding Replacement Window

### Safety Alert Symbol



Recognize this symbol. This is the Safety-Alert symbol. When you see this symbol be alert to the potential for personal injury or product damage.



#### **DANGER**

Falling from window opening may result in serious injury or death. **DO NOT** leave openings unattended when children are present.



#### **WARNING**

Weight of window and door units and accessories will vary. Use a reasonable number of people with sufficient strength to lift, carry and install window or door units and accessories. Always consider site conditions and use appropriate techniques when installing.



#### **DANGER**



#### **CUT HAZARD**

\*Non-safety Glass.  
\*May cause serious injuries if broken.  
\*Do not install where tempered safety glass is required.



#### **DANGER**



Screen will not stop children, any one or anything from falling out window.

Keep children and objects away from open window.

### Synthetic Stucco

Serious concerns have been raised about excessive moisture problems in homes and other buildings that have Exterior Insulation Finish Systems, commonly referred to as EIFS or Synthetic Stucco.

Many experts agree that a certain amount of water or moisture can be expected to enter almost any building exterior system. The building system should allow such water and moisture to escape or "weep" to the exterior, so no damage occurs. However, some EIFS systems may not allow water or moisture that penetrates the wall system to "weep" to the exterior. This can cause excessive moisture to accumulate within the wall system, which can cause serious damage to wall and other building components. It has been reported that so-called "barrier" EIFS systems are particularly prone to this problem.

Moisture problems in any type of building structure can be reduced by proper design and construction with appropriate moisture control considerations, taking into account prevailing climate conditions. Examples of moisture control considerations include flashing and/or sealing of all building exterior penetration points, use of appropriate materials and construction techniques, adherence to applicable building codes, and general attention to proper design and workmanship of the entire building system, including allowances for management of moisture within the wall system.

Determination of proper building design, components and construction, including moisture management, are the responsibility of the design architect, the contractors, and the manufacturer of the exterior wall finish products. Questions and concerns about moisture management issues should be taken up with these professionals. The window manufacturer is not responsible for problems or damages caused by deficiencies in building design, construction or maintenance, failure to install our products properly, or use of our products in systems that do not allow for proper management of moisture within the wall system.

## Tilt and Sliding Replacement Window

### Sash Removal

FIGURE 1

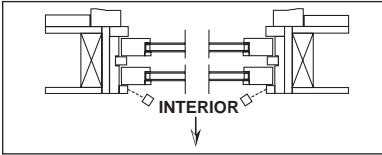

FIGURE 2

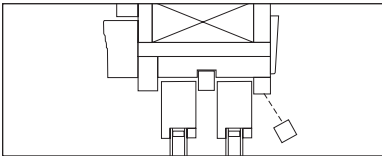

FIGURE 3

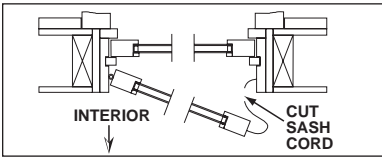

FIGURE 4

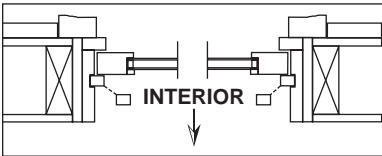

FIGURE 5

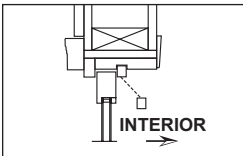
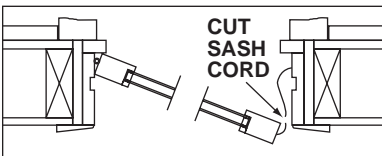



FIGURE 6



#### WARNING

Improper use of hand and power tools could result in personal injury and/or product damage. Follow equipment manufacturers' instructions for safe operation. Always wear safety glasses.

1. Unlock and raise bottom sash. Prop sash open with a block of wood.
2. Use a pry bar or stiff putty knife to pry side (FIGURE 1) and head (FIGURE 2) inside stop mouldings away from jambs. *Handle carefully as these mouldings can be reused.*

 **Move sash slowly and carefully to prevent glass from shattering. Wear full protective clothing including gloves and safety glasses.**

3. Lower bottom sash and prop it up so its bottom edge rests above the stool (Item 12, FIGURE 1, Page iv).
4. Rotate one side of bottom sash inward (FIGURE 3). Cut sash cord.
5. Work sash toward interior and remove cord from opposite side.
6. Safely discard bottom sash.

**NOTE:** If top sash is stationary, remove the support blocks at the bottom of the top sash. If sash is "painted-in", insert a putty knife between sash and the side and head parting stops. Work putty knife around all sides to break paint seal.

7. Lower the top sash and prop its bottom edge slightly above the stool.
8. Use a pry bar or stiff putty knife to pry side parting stops (FIGURE 4) and head parting stop (FIGURE 5) away from side and head jambs. Remove all pieces. The parting stops will not be reused.
9. Rotate one side of sash inward. Cut sash cord (FIGURE 6).
10. Work sash toward interior and remove cord from opposite side.
11. Safely discard top sash.

### Opening Preparation

FIGURE 1



1. Cut sash cords and remove sash weights from both side jambs (**FIGURE 1**).
2. Remove screws and pry out sash rope pulleys (**FIGURE 2**).
3. Remove sash ropes.
4. Install fiberglass insulation in the sash weight and pulley rope cavities (**FIGURE 3**). **Do not over pack insulation.**
5. Examine opening. Remove any objects that would interfere with new window's fit.
6. Clean all loose dirt and paint from opening.

FIGURE 2



FIGURE 3



## Tilt and Sliding Replacement Window

### Opening Preparation (cont.)

FIGURE 4

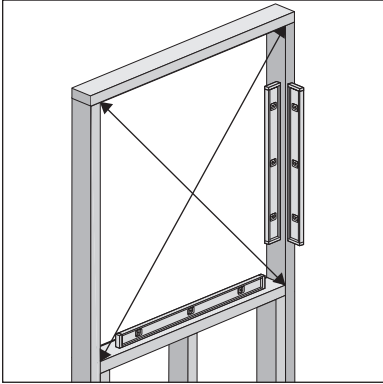

7. Check opening for the following:
  - Rotted components
  - Missing or broken stopsFix any of these conditions before proceeding.

8. Check opening for level, plumb, and square (**FIGURE 4**). Use a level to check the sill, head, and side jambs. Measure the opening diagonally from corner to corner to check for square. Measurements must be within 1/4" of each other. Fix any of these conditions before proceeding.

9. Measure the height (**FIGURE 5**) and width (**FIGURE 7**) of the opening. Do not include the outside stops. Compare these measurements to the height, measured in two locations, (**FIGURE 6**) and frame width (**FIGURE 8**) of the new window.

**The replacement window must be able to fit in the opening and be held from falling through by the outside stops on the sides and head.**

Make necessary adjustments to the opening so this support is provided to the new window.

**⚠ IMPORTANT:** The outside stops (blind stops) cannot exceed 1/2" in depth from the outer edge of the stop to the old window frame (**FIGURE 9**). Check stops around entire opening making adjustments to reach the 1/2" maximum depth.

FIGURE 5

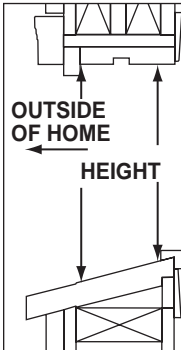

FIGURE 6

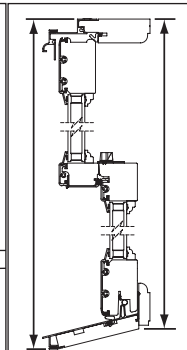

FIGURE 7

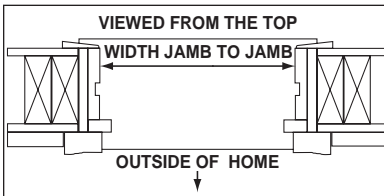

FIGURE 8

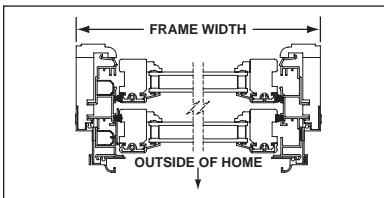
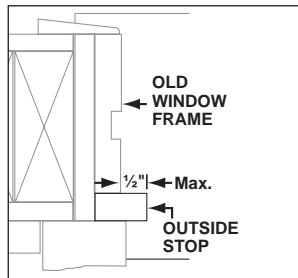

FIGURE 9





### Window Installation – Check Fit

FIGURE 1

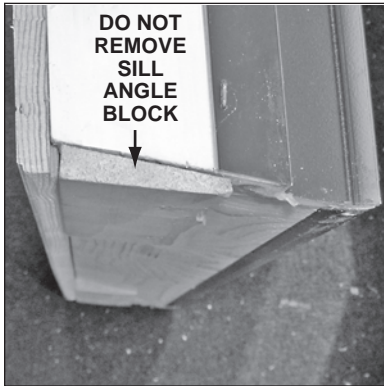

#### **Check Replacement Window Fit**

**NOTE:** Remove all packing. *Do not remove the sill angle blocks (FIGURE 1).* Make sure sash are fully seated in frame and locked. Clean all loose material and dirt from opening. Remove any objects that would damage new unit or interfere with proper fit and sash operation.

1. Insert new window unit into opening to check fit. Unit must fit within the outside stops (**FIGURE 2**) and sit flush against the stop's face.

It may be necessary to chisel a relief area at the bottom of the outside stops to provide space for the unit to rotate into a vertical position (**FIGURE 3**).

Remove window unit after checking fit. Make adjustments to the opening/stops to obtain a good fit. A shim space is needed on sides and top; none required at the sill.

**NOTE:** If your unit came with a sill angle support bracket, turn to Page 6. If it did not come with an angle support bracket, continue on the next page.

FIGURE 2

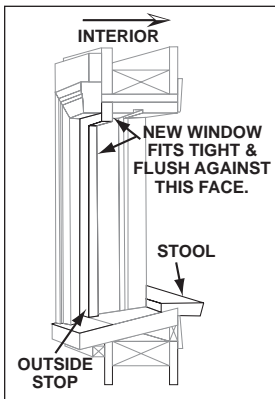
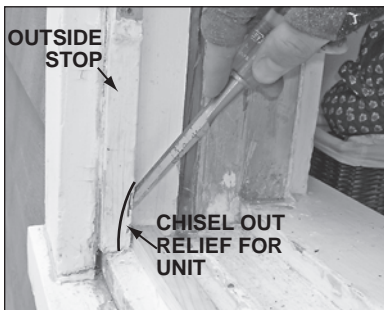

FIGURE 3



## Window Installation (cont.)

FIGURE 4

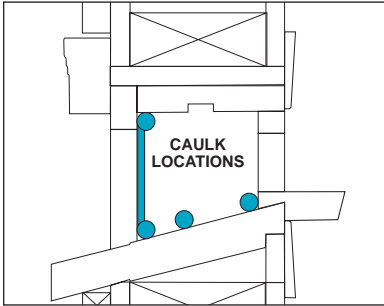

FIGURE 5

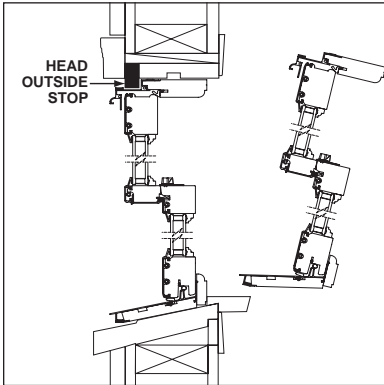

FIGURE 6



### For Units Without Sill Angle Bracket

#### Prepare The Opening



**! DANGER**

**IMPORTANT:** All surfaces to be caulked must be clean and free of loose material so caulk adheres to a solid surface.

1. Use a high-quality, neutral cure, exterior, silicone sealant (compatible with aluminum, the old sill, and jambs). Lay continuous generous caulk beads along the interior side of the head and side outside (blind) stops, and outer face of the stool (**FIGURE 4**).
2. Also lay two additional beads along the sill, from side-to-side, to seal the new unit's sill to the old sill. Be sure all locations shown in (**FIGURE 4**) receive a continuous generous caulk bead.
3. From the interior, lift the window into the opening. Bottom inside edge rests tight against the stool and sits on sill caulking. Outside edges of side frame and head must butt tightly against caulk bead applied to outside stops (**FIGURE 5**).

***Be sure to center window side-to-side in the opening. Centering window is critical for fitting interior and exterior trim.***

4. Push window firmly against the side and head outside stops; seating it in the caulk beads.
5. While holding unit in place, check unit for plumb, level, and square (**FIGURES 6 & 6A**). To check square, measure diagonally from corner to corner. Measurements must be the same. Adjust unit with shims to obtain a level, plumb, and square unit.

**Be sure unit remains centered in opening.**

***For tilt windows, continue on Page 8 with Step 11.***

***For sliding windows continue on Page 10 with Step 11.***

## Window Installation (cont.)

FIGURE 1

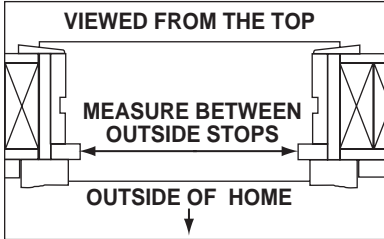

FIGURE 2

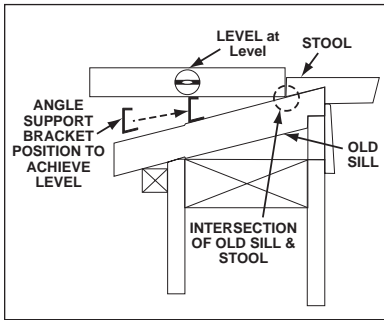

FIGURE 3



### For Units Using The Sill Angle Bracket

#### Prepare The Opening

1. Measure inside width of the opening between the outside stops (**FIGURE 1**). Cut the aluminum angle support bracket to this length.
2. Using a level and the angle support bracket, find the location on the old sill that will provide a level plane between the intersection of the stool and old sill and the top of the angle support bracket (**FIGURE 2**). Mark this location across the sill's width.
3. If attachment holes are not pre-drilled in the angle support bracket, hold bracket at the level location and pre-drill holes for the attachment screws. Space holes evenly along length of angle support bracket.  
  
If bracket is pre-drilled, skip to Step 4.
4. Attach bracket securely to the old sill using the included #8 x 1/2" Phillips pan head, screws (**FIGURE 3**).

## Window Installation (cont.)

FIGURE 4



FIGURE 5

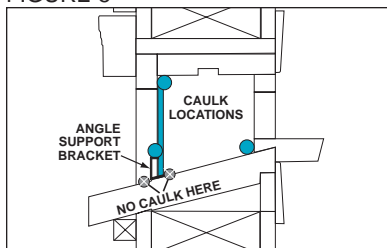

FIGURE 6

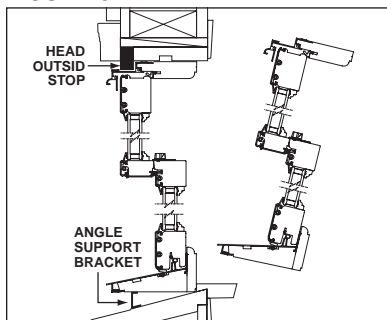

FIGURE 7



### For Units Using The Sill Angle Bracket (cont.)

5. Insulate space between angle support bracket and stool with fiberglass insulation (FIGURE 4). **Do NOT over-pack insulation.**

**⚠ IMPORTANT:** All surfaces to be caulked must be clean and free of loose material so caulk adheres to a solid surface.

6. Use a high-quality, neutral cure, exterior, silicone sealant (compatible with aluminum, the old sill, and jambs). Lay a continuous generous caulk bead along the head and side outside stops (FIGURE 5).
7. Be sure all locations shown in (FIGURE 5) receive a continuous generous caulk bead.

**NOTE:** Do not caulk at the base of the angle support bracket on either the inside or outside.

8. From the interior, lift the window into the opening. Bottom inside edge rests tight against the stool and sits on sill caulking. Outside sill bottom sits on angle support bracket. Outside edges of side frame and head must butt tightly against caulk bead applied to the outside stops (FIGURE 6).

**Be sure to center window side-to-side in the opening. Centering window is critical for fitting interior and exterior trim.**

9. Push window firmly toward the outside stops to seat it in the caulk beads.
10. While holding unit in place, check unit for plumb and level on the interior or exterior (FIGURE 7).

**For tilt windows, continue with Step 11 on the next page.**

**For sliding windows, continue with Step 11, Page 10.**

### Window Installation (cont.)

FIGURE 9 – TILT WINDOW



FIGURE 10



FIGURE 11



**For tilt window only. See Page 10 Step 11 for sliding windows.**

- Using shims provided, shim so unit is level and plumb. Place shims between side jambs (**FIGURE 9**) and head and the old window frame. Locate shims at the pre-drilled fastening holes. Pre-drilled screw holes are located in three places along each side jamb at the top, middle, and bottom.
- When unit is level and plumb, unlock and raise bottom sash.
- With a 3/32" diameter drill bit, create pilot holes in the opening framing using the pre-drilled screw holes in the new window as a location guide. Center holes and drill as straight as possible.
- Fasten unit in opening with #8 x 2-1/2" Phillips bugle head drywall screws provided. Install a screw through the bottom hole on each side.



**CAUTION**

**IMPORTANT: Screws must be installed straight and through the vinyl jamb liner. If screw head catches the jamb liner it will not seat far enough and could interfere with proper sash operation.**

- Carefully remove the bottom sash. See Sash Removal Instructions on Page 14.
- Double check level, plumb and square. Adjust shims if necessary and then drill pilot holes and apply a #8 x 2-1/2" Phillips bugle head drywall screw through the middle hole in each side jamb.
- Lower top sash.
- Remove vinyl sash stop on each side of side jamb (**FIGURES 10 & 11**).

## Tilt and Sliding Replacement Window

### Window Installation (cont.)

FIGURE 12



**For tilt window only. See Page 10 Step 11 for sliding windows.**

**NOTE:** The top pre-drilled fastening hole may be covered by the sash balance S-hook (**FIGURE 12**). Use a flat-bladed screwdriver to slide S-clip out of the way (**FIGURE 13**).

19. Drill pilot holes and apply #8 x 2-1/2" screw through each top hole (**FIGURE 14**).
20. Reinstall vinyl sash stops.
21. Reinstall sash. See Sash Reinstall instructions starting on Page 16.

FIGURE 13

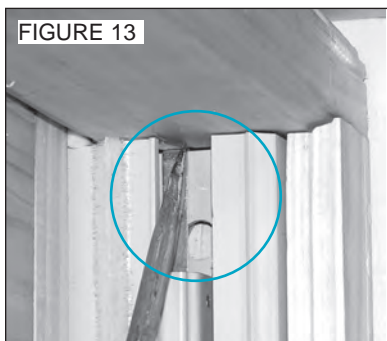
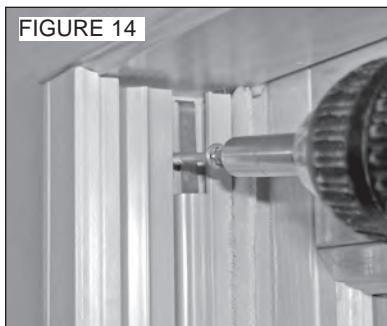

FIGURE 14



### Window Installation (cont.)

FIGURE 10 – SLIDER



FIGURE 11 – SLIDER



#### For sliding windows only.

11. Pre-drilled screw holes are located in two places along each side jamb (**FIGURE 10**). One hole is located in the center of the head jamb.
12. Using shims provided, shim so unit is level and plumb. Place shims between jambs and the old window frame (**FIGURE 10**). Locate shims at the pre-drilled fastening holes.
13. When unit is level and plumb, fasten unit through the side jamb holes opposite the active sash. Use the #10 x 2-1/2" Phillips truss head screws (**FIGURE 11**).
14. Unlock and open sash. Double check level, plumb and square. Adjust shims if necessary and then apply a #10 x 2-1/2" Phillips truss head screw through each hole in the side jamb.
15. Remove sash. See sash removal instructions starting on Page 19.
16. Apply the provided #8 x 2-1/2" Phillips bugle head screw through the single hole located in the middle of the head jamb.
17. Reinstall sash. See sash reinstallation instructions starting on Page 21.

## Tilt and Sliding Replacement Window

### Window Installation (cont.)

FIGURE 15



#### For tilt and sliding windows

22. Loosely insulate between the new window jambs and the old window frame with fiberglass insulation (**FIGURE 15**). Low expansion foam insulation, specifically rated for window and door application, may be used instead of fiberglass.
23. Use appropriate length finish nails and reinstall the head and side inside stops.

**NOTE:** If any inside stops or the casing mouldings were damaged during removal, install new pieces (**FIGURE 16**).

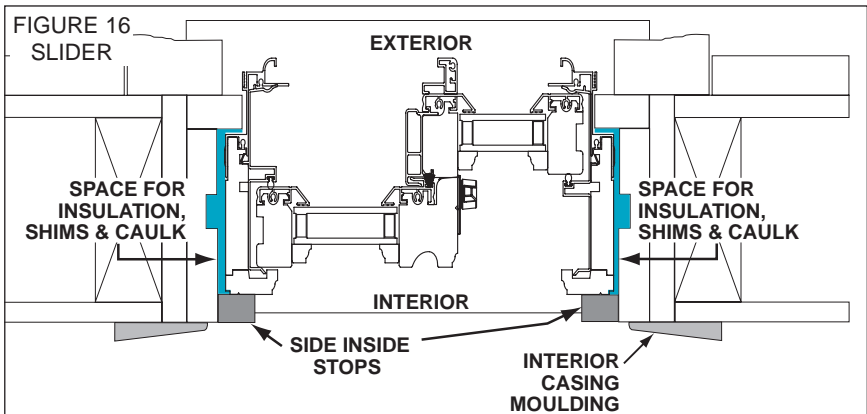
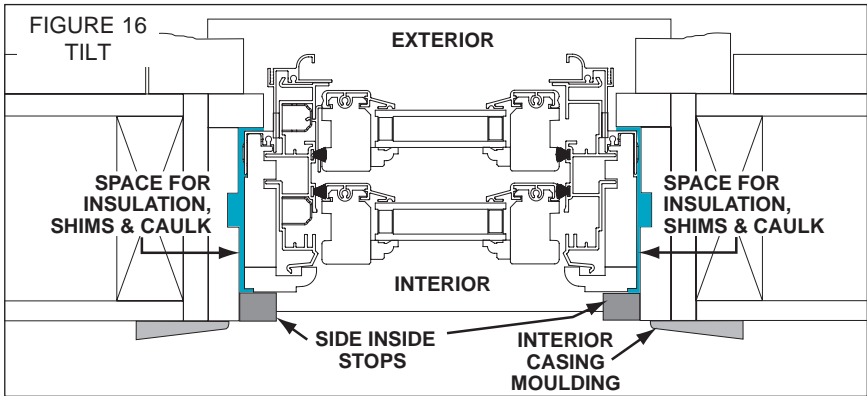



## Optional Exterior Trim Application

FIGURE 1

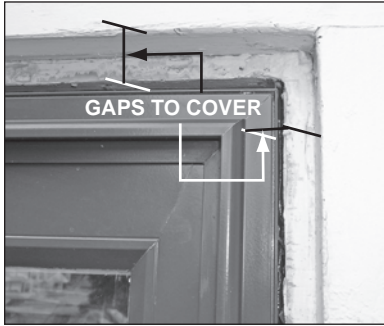

Gaps (**FIGURE 1**) between the window, and the siding or brickmould can be covered with optional color-matched aluminum trim.

Aluminum trim will be factory pre-cut to nominal length. Each piece will be too long so it can be adjusted to fit each window opening.

Trim will be notched at the ends (**FIGURE 2**) so it can run past the window cladding and reach out to the existing siding or casing mouldings.

FIGURE 2



FIGURE 3



The head piece must be applied with a notch at each end. The side pieces are cut flat at the top and notched at the bottom. The sill piece is cut flat on both ends.

(**FIGURE 3**) shows the length measuring locations.

Trim width is determined by distance measured from the exterior accessory groove to the existing casing moulding or siding and the sill. The **X** in (**FIGURE 4**) shows a typical width measurement.

FIGURE 4

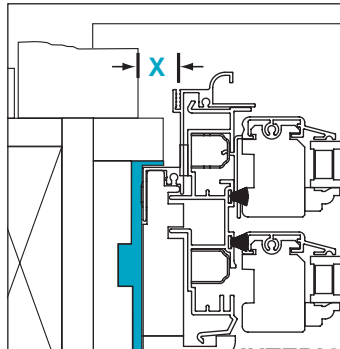

### Optional Exterior Trim Application (cont.)

FIGURE 5

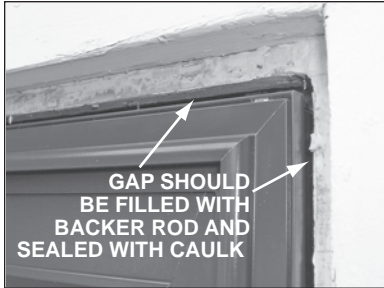

FIGURE 6



FIGURE 7



FIGURE 8

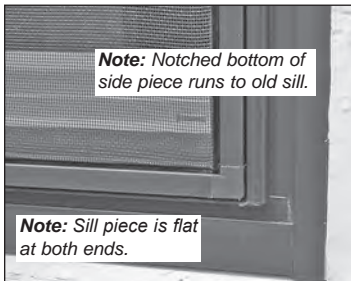

#### Proceed as follows:

1. Fill gap between new window frame and old with backer rod and then seal with a bead of caulk (FIGURE 5).

**⚠ IMPORTANT:** Head notched piece must be cut to final length by removing an equal amount from each end.

2. Measure and cut head piece to length and width. Use a table saw properly equipped with an aluminum cutting blade, a hack saw, or tin snips.

**⚠ DANGER** Follow all procedures for safe table saw operation. Wear safety glasses and hearing protection.

**⚠ CAUTION** Cut edges can be sharp. Wear gloves and handle carefully to prevent injury.

3. After trim is cut to size, remove sharp or rough edges.
4. Install head piece (FIGURE 6). Trim is applied by inserting short leg into window's accessory groove (FIGURE 7).
5. Measure, cut and install side pieces. Side trim runs from bottom of head piece to old sill and is flat at the top and notched at the bottom (FIGURES 7 & 8).
6. Measure, cut, and install sill piece. Sill trim fits between the two side pieces and is cut flat at both ends (FIGURE 8).
7. Use a padded wood block and hammer to ensure all trim pieces are fully seated in the accessory groove.
8. Complete the trim installation by caulking any remaining gaps between the trim and siding or brickmould (FIGURE 9).

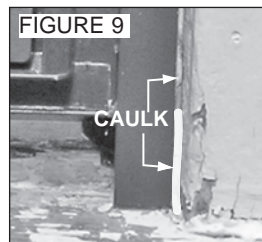

### Tilt Window Lock and Unlock

FIGURE 1

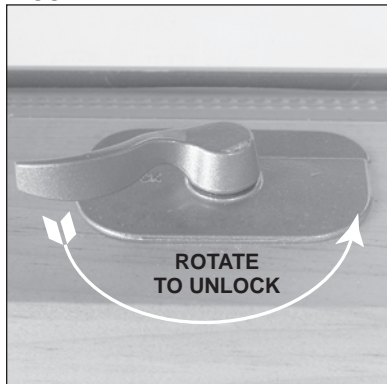
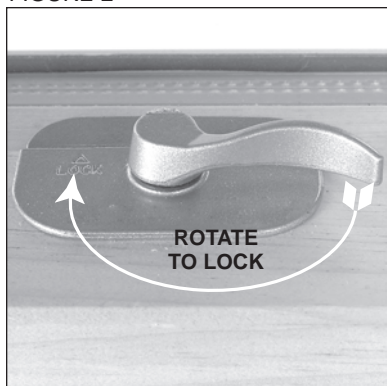

FIGURE 2



**NOTE:** On double hung units, both the bottom and top sash operate. They can each be positioned as desired.

#### **DOUBLE HUNG TILT**

1. To unlock unit, rotate sash lock lever as far as it will go counter clockwise (**FIGURE 1**).
2. To lock unit raise upper sash as far as it will go making sure it fully seats in the head jamb.
3. Completely lower bottom sash and move sash lock lever as far as it will go clockwise (**FIGURE 2**). The lock's cam must engage the keeper in the upper sash.

#### **⚠ WARNING**

If removing or tilting sash while standing on a ladder or step stool, be careful not to lose your balance.

#### **⚠ WARNING**

Sash can be heavy and caution should be used when removing or installing. It is recommended that the sash be handled with an adequate number of people.

#### **⚠ WARNING**

- Use care when working on ladders and scaffold, falls could occur.
- Follow all safety procedures recommended by ladder, scaffold and tool manufacturers'.
- Use care when working around window openings, a fall could occur.

## Tilt and Sliding Replacement Window

### Tilt Window Sash Removal

FIGURE 1

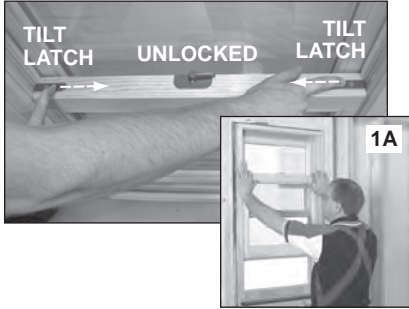

FIGURE 2

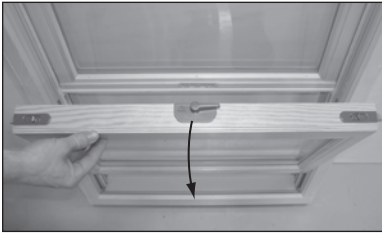

FIGURE 3



1. Unlock and raise bottom sash approximately 4" (**FIGURE 1A**). With index fingers, slide tilt latches (on top of bottom sash) (**FIGURE 1**) towards center of window until latches clear the side jambs.
2. While holding tilt latches in retracted position, pull or tilt top of sash in toward you. Once meeting rail clears the side jambs, the tilt latches may be released. Sash now tilts in for cleaning, while remaining hinged at the bottom (**FIGURE 2**).
3. To remove the bottom sash, tilt sash in so it is at a right angle to the window frame (**FIGURE 3**). Grasp the sash firmly on both sides and lift one side straight up to disengage the sash pivot pin (**FIGURE 4**). Lift the opposite side up and out of the side jamb.
4. To tilt or remove top sash, the bottom sash must be first tilted in or removed. Lower the top sash to about 12" from the bottom of the unit. Unlatch and tilt or remove following the same steps as for the bottom sash.

FIGURE 4



## Tilt and Sliding Replacement Window

### Tilt Window Sash Reinstall

FIGURE 1



FIGURE 2

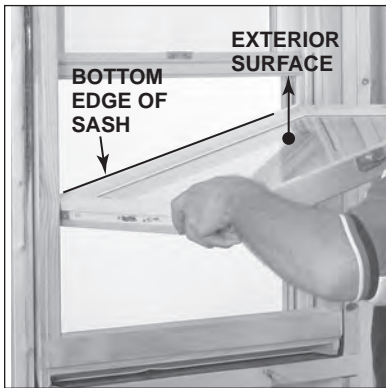
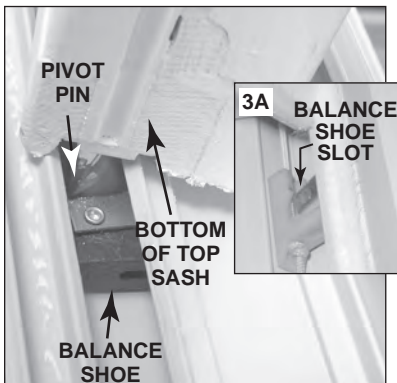

FIGURE 3



#### NOTE: DOUBLE HUNG TILT

Install top sash first. Top sash is placed into the outer track. Bottom sash is placed into the inner track (FIGURE 1).

#### SINGLE HUNG TILT

Only the lower sash is removable.

**⚠ IMPORTANT:** If your unit is a double hung tilt, the top sash must be completely installed in the side jamb's outer tracks before the bottom sash can be installed.

#### ⚠ WARNING

If pivot pins are placed below balance shoes the pivot pins will not be supported. Sash will have no counter balance and could fall rapidly possibly causing personal injury or property damage. When inserting sash in frame, pivot pins **MUST BE ABOVE** the balance shoes.

**⚠ IMPORTANT:** When placing sash into side jambs, the sash pivot pins **MUST BE ABOVE** the balance shoes so the latching mechanism in the shoe will engage the pivot pins when the sash is lowered into the balance shoes.

#### For Either Sash

On a double hung unit, the top sash must be reinstalled first. Top sash installs in outer track.

The bottom sash, whether single hung or double hung, installs into the inner track.

1. Grasp the sash so that the exterior surface is up (FIGURE 2) and the bottom edge of the sash faces the window (pivot pins are located at the bottom edge of the sash) (FIGURE 3).
2. With one side of the sash angled up (FIGURE 2), place pivot pin so it sits on the top of the balance shoe in the side jamb (FIGURE 3). Lower opposite side of the sash, so that its pivot pin is above opposite side balance shoe (FIGURE 3A).
3. Align the pivot pin with the slot on the balance shoe (FIGURES 3 & 3A).
4. Slide sash down until each pivot pin fully engages the balance shoe slot.

### Tilt Window Sash Reinstall (cont.)

FIGURE 4



5. After pivot pins are fully engaged in balance shoes, tilt or push the top of the sash up and away from you until the tilt latches on top of sash snap into both side jamb liners (**FIGURES 4 & 5**). Tug gently inward on top of each sash to check tilt latch engagement.

**⚠** Be sure tilt latches on both sides of each sash are fully seated (**FIGURES 6 & 7**) to keep window from unintentionally falling inward.

FIGURE 5



FIGURE 6 – BOTTOM SASH



FIGURE 7 – TOP SASH





### Tilt Window Screen Removal and Reinstallation

FIGURE 1



FIGURE 2

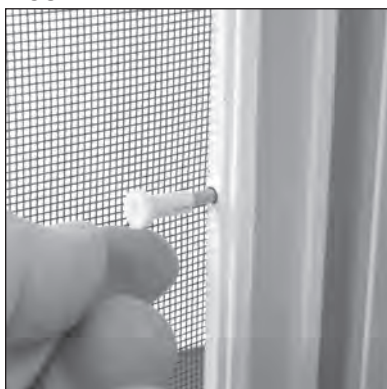

FIGURE 3



**⚠ DANGER**

**About Children:** The consumer Product Safety Commission, in its pamphlet *Protect your Child*, advises: "Keep children away from open windows to prevent falls. Don't depend on screens to keep the child from falling out the window. They are designed to keep insects out, not children in. Avoid placing furniture near windows to keep children from climbing to a window seat and sill."

**⚠ DANGER**



Screen will not stop children, any one or anything from falling out window.

Keep children and objects away from open window.

1. Unlock and arrange sash so they line up as in **(FIGURE 1)**.
2. Pull and hold the spring-loaded plungers **(FIGURES 1 & 2)**, located on either side of the screen, towards the center of the window unit and then tilt the screen away from the side jamb **(FIGURE 1)**.

**⚠ CAUTION** Prevent injury or death from falling screen. Maintain secure grip on screen until it is safely back inside the structure.

3. Tilt and maneuver screen to bring it inside the house **(FIGURE 3)**.

#### **Screen Reinstallation**

Reverse above steps to reinstall the screen. Be sure plungers are fully seated to hold the screen securely in place.

### Sliding Window Sash Lock and Unlock

FIGURE 1

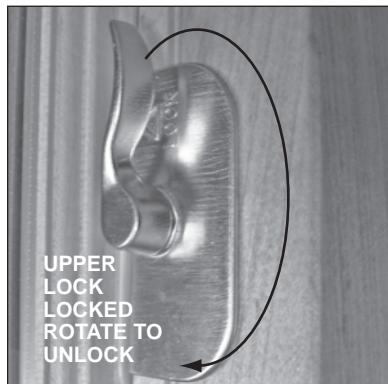
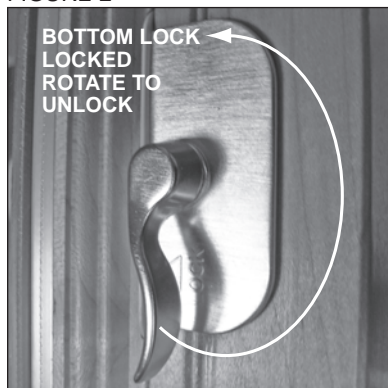

FIGURE 2



The number of sash locks is determined by window height.

For units with a top and bottom lock:

1. To **lock** unit, slide sash toward side jamb until it is completely closed. Rotate top sash lock lever so it points fully up (**FIGURE 1**). Rotate bottom sash lock so it is fully down (**FIGURE 2**). The lock cams must engage the keepers in the meeting rail.
2. Unit is **unlocked** when top sash lock lever is rotated to point fully down and the bottom sash lock lever is rotated to point fully up.

**NOTE:** If your unit has a single sash lock, it operates the same as the bottom sash lock (**FIGURE 2**).

#### WARNING

- Use care when working on ladders and scaffold, falls could occur.
- Follow all safety procedures recommended by ladder, scaffold and tool manufacturers'.
- Use care when working around window openings, a fall could occur.

Sash can be heavy and caution should be used when removing. It is recommended that the sash be removed with adequate number of persons.



## Tilt and Sliding Replacement Window

### Sliding Window Sash Removal

**⚠ WARNING** Hold on to sash. Once top of sash is tilted clear of head jamb there is no support for the sash. You **MUST** hold sash to keep it from falling.

FIGURE 1



FIGURE 2



FIGURE 3



#### Sash Removal – Single Slider

1. Unlock and slide inner sash open enough to clear side jambs and allow you to firmly grip sash on both sides (**FIGURE 1**).
2. With index fingers, slide tilt latches (on top of sash on both sides) down towards window sill until latches clear the head jamb (**FIGURE 2**).
3. While holding tilt latches in retracted position, tilt top of sash in toward you (**FIGURE 3**).
4. After the top of the sash is tilted clear of the head jamb, grasp the sash firmly on both sides and lift up and off the sill track (**FIGURE 4**).

#### Sash Removal – Triple Slider

Follow Steps 1 through 4 above.

FIGURE 4



### Sliding Window Sash Reinstall

FIGURE 1



FIGURE 2



FIGURE 3

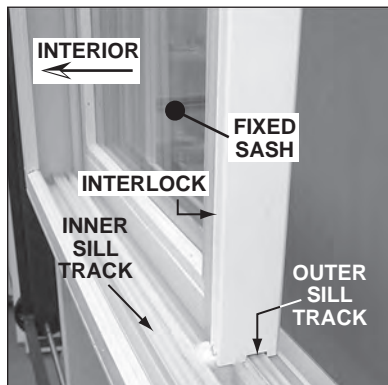

FIGURE 4



1. Arrange sash so sash rollers (**FIGURE 1**) are down toward the sill and the interlock is toward the exterior and the middle of the window (**FIGURE 2**).
2. With the sash centered on the opening, seat the sash rollers on the inner sill track (**FIGURES 2 & 3**).
3. Retract tilt latches by pulling down on the two thumb buttons on each side of the sash (**FIGURE 4**).
4. While holding tilt latches retracted (**FIGURE 4**), rotate top of sash outward until sash is fully seated in the head jamb (**FIGURE 5**) while sash rollers remain on sill track.

*Continued on next page.*

FIGURE 5



### Sliding Window Sash Reinstall (cont.)

FIGURE 6



#### **Reinstall Sash (cont.)**

5. When sash is vertical, release the tilt latches to engage the head jamb (FIGURE 6).



**CAUTION** Be sure tilt latches on both sides are fully seated (FIGURE 6) to keep sash from unintentionally falling inward.



**IMPORTANT:** Sash must be fully seated in the head jamb so the interlock, between active and fixed sash, will properly engage when the window is completely closed (FIGURE 7).

FIGURE 7

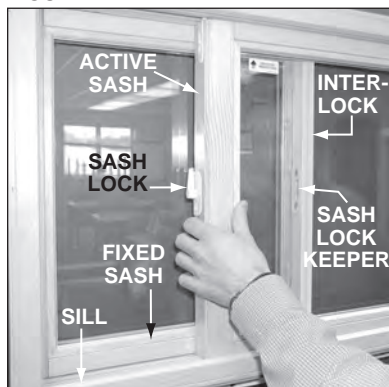

### Sliding Window Screen Removal and Reinstallation

FIGURE 1



FIGURE 2



FIGURE 3



FIGURE 4

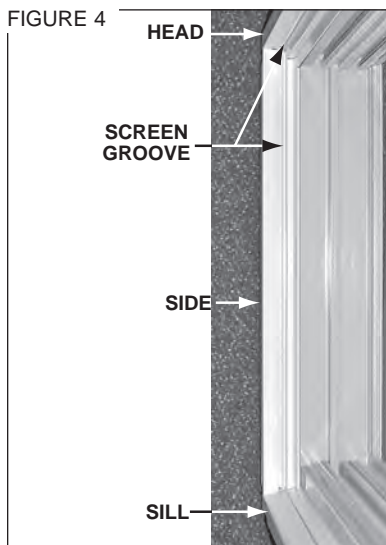

#### DANGER

About Children: The consumer Product Safety Commission, in its pamphlet *Protect your Child*, advises: "Keep children away from open windows to prevent falls. Don't depend on screens to keep the child from falling out the window. They are designed to keep insects out, not children in. Avoid placing furniture near windows to keep children from climbing to a window seat and sill."

1. Open one sash all the way.
2. Reach through opening and pull both spring-loaded plungers, on side of screen, in toward the center of the window (**FIGURE 1**).
3. While holding spring-loaded plungers in this retracted position, push edge of screen outward to clear window frame (**FIGURE 2**).

 **WARNING** Keep a firm grip on screen to prevent it from falling or being blown from your hand.

4. Re-grip screen, rotate and bring screen inside (**FIGURE 3**).

#### Screen Reinstall

1. Open sash all the way.
2. Position screen so spring loaded plungers are to the interior and toward the side jambs.
3. Maneuver screen through open window and align plunger buttons (sticking out from the screen's edge) with screen groove in the window frame at the side and head (**FIGURE 4**).
4. Align and insert the plunger buttons, on the far side of the screen, with their side and head jamb grooves. Pull the near end of the screen frame inward.
5. Pull the spring-loaded plungers toward the center of the window and continue pulling screen inward.
6. Release spring-loaded plungers when plunger buttons align with the grooves. Check that all the spring-loaded plungers are fully seated in the screen grooves.

### Recommended Finishing Instructions

#### WARNING

Always follow chemical manufacturers' safety instructions when using chemicals to avoid injury or illness.

Vinyl and aluminum may be cleaned with mild soap and water. Hard to remove stains and mineral deposits may be removed with mineral spirits. Factory-applied painted surfaces can be cleaned with mild household detergents and water.

- **Do NOT** clean any surface with gasoline, diesel fuel, solvent based, or petroleum based products.
- **Do NOT** use abrasive materials or strong acidic solutions against vinyl, aluminum, glass, or factory-applied finishes.
- **Do NOT** scrape or use tools that might damage the surface.
- **Do NOT** paint vinyl or aluminum surfaces.
- **Do NOT** use mastic-type tapes such as Duct Tape<sup>®</sup>.

**NOTE:** If masking tape is used on any surface to aid in painting or staining, remove tape as soon as possible after use. Tape must be removed within 24 hours of application.

For long term use, such as stucco applications; use tape that will release, even when exposed to high temperatures for an extended period of time. (Examples include 3M #2080 and #2090 tapes.)

#### **For Bare Wood Surfaces**

For best results, wood should be sealed immediately upon installation or upon receipt, especially if unit is being stored for ANY length of time.

1. Remove all construction and adhesive label residue with mineral spirits before finishing.
2. Lightly sand surfaces being finished with 180 grit or finer sandpaper. Be careful not to scratch the glass.
3. After sanding, clean-off sanding dust

using lacquer thinner applied to a cloth so the cloth is slightly damp. Let surface dry completely.

#### **If a painted surface is desired:**

- If a wood unit is delivered with factory-applied primer paint, it may be painted without repriming, providing the finish paint coat is applied within six (6) months of unit installation.
  - ◊ Inspect all primed surfaces. Remove any surface roughness with 220 or finer sandpaper and light sanding. Reprime sanded areas and allow to dry before proceeding.
- If a factory-primed wood unit requires repriming contact your customer service representative for help in selecting a primer compatible with the factory applied material.
- Factory-applied Accentials™ color system finishes in standard, designer or custom colors do not require additional painting. For "touch up" paint specifications contact your customer service representative.
  1. An unprimed wood unit requires priming. Use only oil-based primer. Use compatible oil or water-based finish coats. Refer to the primer and paint manufacturers' instructions.
  2. When priming bare wood or repriming, cover all exposed wood surfaces. Priming all exposed surfaces helps prevent end splitting, warping and/or checking.
  3. Once primed, apply two (2) coats of paint (again on all exposed sides) to each item.

*Continued on next page.*

## Recommended Finishing Instructions (cont.)

If a stained surface is desired:

**⚠ DANGER** If no sealer is applied over stain, the wood will weather very rapidly and defects will occur. Apply at least two (2) coats of sealer.

1. Use only oil-based stain. A gel stain is easier to apply as it does not easily run or drip. The clear top coats may be oil or water-based. Apply at least two top coats of sealer or varnish.
- A pre-stain wood conditioner, applied before staining, will help softer woods like pine absorb stain more evenly. Apply both wood conditioner and desired stain according to the manufacturers' instructions.
2. Apply one (1) coat of sealer to the stained surface and let dry. Using a spar (marine) varnish as a sealer provides extra protection against sunlight and moisture. Let sealer dry completely.
3. Before applying the next finish coat, make sure the previous coat is completely dry. Then lightly sand previous finish coat with 180 grit or finer sand-

paper. Clean off all sanding dust and wipe surfaces with a tack cloth.

4. Apply next coat of desired finish to surface and let dry. Apply only one coat at a time.
5. For any additional coats of finish, repeat steps 3 and 4.

**For a clear (natural) finish:**

Follow Steps 1, 2, and 3 under "Bare Wood" and Steps 2, 3, 4, and 5 under "stained surface".

**⚠ IMPORTANT:** Remove sash for finishing. Apply your choice of sealer (paint or varnish) to all exposed bare wood components (FIGURE 1). Do not get sealer on weather strip, vinyl, or into mechanical components (sash lock, tilt latches or pivot pins). Ensure bottom and top of sash are also sealed.

**⚠ WARNING** Sealer (paint or varnish) applied to sash **MUST DRY COMPLETELY** before reinstalling sash. If not dry, sash may stick in jamb liners. Also weather strip and jamb liners may be damaged.

